

# VICTORIA BED FRAME/SINGLE/Assembly Instruction

Box  
2 of 2 ← A2

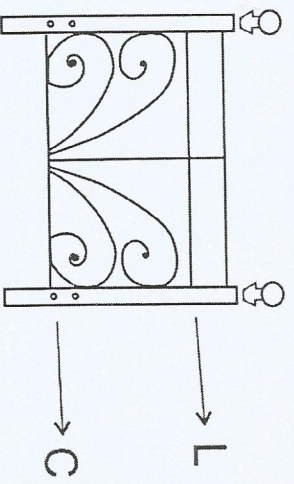

B1



Box

C1

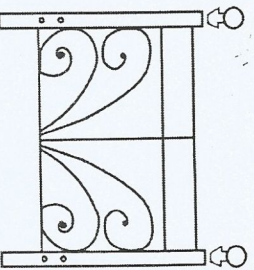

1 of 2

D1

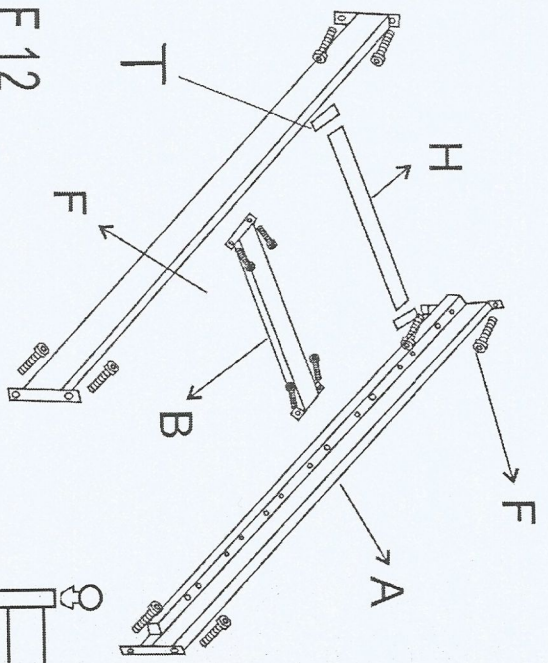
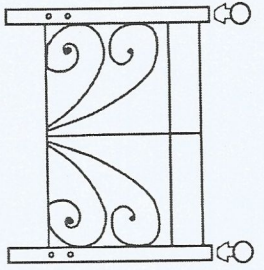

M8 X 20 F 12

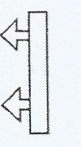

T 28

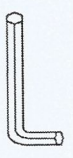

G 1



H 14



L 4

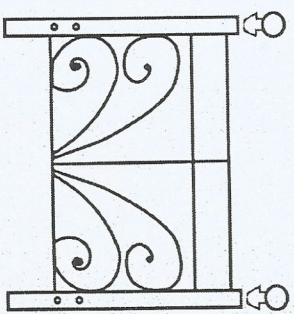

D